

CPN 51956043

INSTRUCTION MANUAL

For Model:
PB35A, PB35AS & PB50A, PB50A
Paving Breakers

Instruktionshåndbog for Paving
Breaker Modellerne: PB35A, PB35AS,
PB50A & PB50AS

HANDLEIDING

voor bestratingsbreekhamer,
modellen PB35A, PB35AS en
PB50A, PB50AS

MANUEL D'INSTRUCTIONS

Pour brise-béton, du type PB35A,
PB35AS et PB50A, PB50AS

BETRIEBSANLEITUNG

für die Aufbruchhämmer-Modelle:
PB35A, PB35AS und PB50A, PB50AS

ΟΔΗΓΟΣ ΧΡΗΣΕΩΣ

Για Μοντέλα Κρουστικών Αεροσφυρών:
PB35A, PB35AS & PB50A, PB50AS

MANUALE DI ISTRUZIONI

per i Martelli Demolitori Pneumatici,
Modelli PB35A, PB35AS e PB50A,
PB50AS

INSTRUKSJONSHÅNDBOK

For trykklufthammermodellene:
PB35A, PB35AS og PB50A, PB50AS

MANUAL DE INSTRUÇÕES

Para Modelos de Martelos
Pneumáticos Manuais de
Demolição : PB35A, PB35AS &
PB50A, PB50AS

MANUAL DE INSTRUCCIONES

Para Martillos rompedores Modelos:
PB35A, PB35AS y PB50A, PB50AS

INSTRUKTIONSBOK för tryckluftspett
med beteckning: PB35A, PB35AS,
PB50A, PB50AS

INGERSOLL-RAND®

Read this instruction manual before
operating this equipment.



Always follow manufacturer instructions

AAA Rent-All 225-291-1356

CPN 51956043

INSTRUCTION MANUAL

For Model:
PB35A, PB35AS, PB50A & PB50AS
Paving Breakers



Read this instruction manual before
operating this equipment.

INGERSOLL-RAND®

Designed and Built by Ingersoll-Rand Company
Roanoke, Va. 24019-5198 U.S.A.



Certified ISO-9001 (ANSI/ASQC Q91)
Certification No. QSR-80

Refer All Communications To The Nearest Address Listed On The Back Cover.

Warranty

Ingersoll-Rand, through its distributor, warrants that each item of equipment manufactured by it and delivered hereunder to the initial user to be free of defects in material and workmanship for a period of three (3) months from initial operation or six (6) months from the date of shipment to the initial user, whichever first occurs.

With respect to the following types of equipment, the warranty period enumerated will apply in lieu of the foregoing warranty period.

- A. Aftercoolers, Drill Mountings and Klemm Rotary Heads – The earlier of six (6) months from initial operation or nine (9) months from date of shipment to the initial user.
- B. Portable Compressors, Portable Generator Sets (GENSET), Portable Light Towers and Abrasive Blasting Equipment. The earlier of twelve (12) months from shipment to, or the accumulation of 2,000 hours of service by, the initial user.
- C. All Compressor Air Ends, GENSET Generators and Paving Breakers – The earlier of twenty-four (24) months from shipment to, or the accumulation of 4,000 hours of service by, the initial user. For Air Ends, the warranty against defects will include replacement of the complete Air End, provided the original Air End is returned assembled and unopened.
- D. Pavers, Milling Machines, Pedestrian Compactors (including baseplates, upright and walk behinds) and Rotary Drills – The earlier of (6) months from shipment to, or the accumulation of 1,000 hours of service by, the initial user.
- E. Jackhammers, Forklifts and Self-Propelled Compactors – The earlier of twelve (12) months from shipment to, or the accumulation of 1,000 hours of service by, the initial user.
- F. Downhole Drills – In lieu of the repair or replacement of defective parts Ingersoll-Rand may elect to

issue full or partial credit toward the purchase of a new part. The extent of credit issued will be determined by pro rating against the normal service life of the part in question.

- G. Spare Parts (excluding downhole drills) – Three (3) months from date of shipment.

Ingersoll-Rand will provide a new part or repaired part, at its election, in place of any part which is found upon its inspection to be defective in material and workmanship during the period prescribed above. Such part will be repaired or replaced without charge to the initial user during normal working hours at the place of business of an Ingersoll-Rand distributor authorized to sell the type equipment involved or other establishment authorized by Ingersoll-Rand. User must present proof of purchase and date at the time of exercising warranty.

This warranty does not apply to failures occurring as a result of abuse, misuse, negligent repairs, corrosion, erosion and normal wear and tear, alterations or modification made to the product without express written consent of Ingersoll-Rand; or failure to follow the recommended operating practices and maintenance procedures as provided in the product's operating and maintenance publications.

Accessories or equipment furnished by Ingersoll-Rand, but manufactured by others, including, but not limited to, engines, tires, batteries, engine electrical equipment, hydraulic transmissions, carriers, shall carry whatever warranty the manufacturers have conveyed to Ingersoll-Rand and which can be passed on to the initial user.

THIS WARRANTY IS IN LIEU OF ALL OTHER WARRANTIES (EXCEPT OF TITLE), EXPRESSED OR IMPLIED, AND THERE ARE NO WARRANTIES OF MERCHANTABILITY OR OF FITNESS FOR A PARTICULAR PURPOSE.

Limitation of Liability

THE REMEDIES OF THE USER SET FORTH UNDER PROVISIONS OF WARRANTY OUTLINED ABOVE ARE EXCLUSIVE AND THE TOTAL LIABILITY OF INGERSOLL-RAND OR ITS DISTRIBUTORS WITH RESPECT TO THIS SALE OR THE EQUIPMENT AND SERVICE FURNISHED HEREUNDER, IN CONNECTION WITH THE PERFORMANCE OR BREACH THEREOF, OR FROM THE SALE, DELIVERY, INSTALLATION, REPAIR OR TECHNICAL DIRECTION COVERED BY OR FURNISHED UNDER THIS SALE. WHETHER BASED ON CONTRACT, WARRANTY, NEGLIGENCE, INDEMNITY, STRICT LIABILITY OR OTHERWISE SHALL NOT EXCEED THE PURCHASE PRICE OF THE UNIT OF EQUIPMENT UPON WHICH SUCH LIABILITY IS BASED.

INGERSOLL-RAND, ITS SUPPLIER(S) AND ITS DISTRIBUTORS SHALL IN NO EVENT BE LIABLE TO THE USER, ANY SUCCESSORS IN INTEREST OR ANY BENE-

FICIARY OR ASSIGNEE RELATING TO THIS SALE FOR ANY CONSEQUENTIAL, INCIDENTAL, INDIRECT, SPECIAL OR PUNITIVE DAMAGES ARISING OUT OF THIS SALE OR ANY BREACH THEREOF, OR ANY DEFECTS IN, OR FAILURE OF, OR MALFUNCTION OF THE EQUIPMENT UNDER THIS SALE WHETHER BASED UPON LOSS OF USE, LOST PROFITS OR REVENUE, INTEREST, LOST GOODWILL, WORK STOPPAGE, IMPAIRMENT OF OTHER GOODS, LOSS BY REASON OF SHUTDOWN OR NON-OPERATION, INCREASED EXPENSES OF OPERATION OF THE EQUIPMENT, COST OF PURCHASE OF REPLACEMENT POWER OR CLAIMS OF USERS OR CUSTOMERS OF THE USER FOR SERVICE INTERRUPTION WHETHER OR NOT SUCH LOSS OR DAMAGE IS BASED ON CONTRACT, WARRANTY, NEGLIGENCE, INDEMNITY, STRICT LIABILITY OR OTHERWISE.

Title

Section

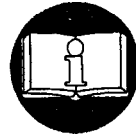

Read this instruction manual before
operating this equipment.

INTRODUCTION	1
Foreword	
Introduction	
Reference Material	
SAFETY	2
Introduction	
Safety Alert Symbol and Signal Words	
Safety First	
Safety Precautions	
DESCRIPTION	3
Description	
Introduction	
Optional Equipment	
Standard Equipment	
INSTALLATION AND OPERATION	4
Air Requirements	
Air Hose and Fittings	
Before Operation	
Controls	
Introduction	
Lubrication	
Lubricating Oil Specifications	
Methods of Lubrication	

(CONTINUED)



TABLE OF CONTENTS (CON'T.)

Title	Section
INSTALLATION AND OPERATION (CON'T.)	4
Operation Operational Tips	
SPECIFICATIONS	5
Lubricating Oil Chart Paving Breaker Illustration Paving Breaker Specifications Vibration and Noise Data	

NOTE: THE VERTICAL BAR SHOWN TO THE LEFT OF TEXT DESIGNATES A REVISION HAS BEEN MADE SINCE THE PREVIOUS PRINTING.

Alphabetical Index

<u>Title</u>	<u>Page No.</u>
Foreword	1
Introduction	1
Reference Material	1

1. FOREWORD.

The contents of this manual are considered to be proprietary and confidential to Ingersoll-Rand® and should not be reproduced for distribution without the prior written consent of Ingersoll-Rand® Company.

Nothing contained in this document is intended to extend any promise, warranty or representation, expressed or implied, regarding the products described herein. Any such warranties or other terms and conditions of sale of products shall be in accordance with Ingersoll-Rand's standard terms and conditions of sale for such products, which are available upon request.

Ingersoll-Rand® Company reserves the right to make changes or add improvements to products without notice and without incurring any obligation to make such changes or add such improvements to products sold previously.

All equipment, regardless of how well built, require a certain amount of attention. The purpose of this publication is to acquaint an operator with the function and operation of the components to obtain maximum performance and trouble free service from the paving breaker.

Before using the paving breaker, these instructions should be carefully read to obtain a thorough knowledge of the duties to be performed. Take pride in the paving breaker, keep it clean; and in good mechanical condition.

2. INTRODUCTION.

This instruction manual contains information on safety, installation, operation, description, and specifications for the Paving Breaker Models PB35A, PB35AS, PB50A & PB50AS.

3. REFERENCE MATERIAL.

The reference materials required to operate and/or maintain the paving breaker are listed in Table 1.

Table 1. Reference Material

Manual No.	Title of Manual
■ PL6087	■ Parts Lists For Paving Breaker Models PB35A, PB35AS, PB50A & PB50AS.
■ RM6087	■ Repair And Maintenance Manual For PB35A, PB35AS, PB50A & PB50AS.

NOTICE

SAVE THESE INSTRUCTIONS. DO NOT DESTROY.

NOTICE

All information, illustrations, and specifications in this manual are based on the latest information available at the time of publication.

Product improvement is a continuing goal at Ingersoll-Rand®. Design and specifications are subject to change without notice or obligation.

The use of repair parts other than those included within the Ingersoll-Rand® approved parts list may create hazardous conditions over which Ingersoll-Rand® Company has no control. Therefore Ingersoll-Rand® Company cannot be held responsible for equipment in which non-approved repair parts are installed.

When the life of the tool has expired, it is recommended that the tool be disassembled, degreased and parts be separated by material so that they can be recycled.

Alphabetical Index

<u>Title</u>	<u>Page No.</u>
Introduction	1
Safety Alert Symbol and Signal Words	1
Safety First	1
Safety Precautions	2

1. INTRODUCTION.

This section contains important safety information for the Paving Breaker Models PB35A, PB35AS, PB50A & PB50AS.

▲ DANGER

DANGER IS USED TO INDICATE THE PRESENCE OF A HAZARD WHICH WILL CAUSE SEVERE PERSONAL INJURY OR DEATH IF THE WARNING IS IGNORED.

2. SAFETY FIRST.

SAFETY FIRST is the primary concern for the protection of both, personnel and the paving breaker during any phase of operation. All personnel must thoroughly understand all safety precautions before operating or doing any maintenance work on the paving breaker.

▲ WARNING

WARNING IS USED TO INDICATE THE PRESENCE OF A HAZARD WHICH CAN CAUSE SEVERE INJURY OR DEATH IF THE WARNING IS IGNORED.

3. SAFETY ALERT SYMBOL AND SIGNAL WORDS.

▲ – This is the Safety Alert Symbol. When you see this symbol in this instruction manual, be alert to the presence of a hazard.

▲ CAUTION

CAUTION IS USED TO INDICATE THE PRESENCE OF A HAZARD WHICH WILL OR CAN CAUSE PERSONAL INJURY, OR PROPERTY DAMAGE IF THE WARNING IS IGNORED.

NOTICE

All personnel must understand the **DANGER, WARNING, CAUTION,** and **NOTICE** used throughout the text of this instruction manual. The **DANGER, WARNING, CAUTION,** and **NOTICE** are defined as follows:

Notice is used to notify people of installation, operation, or maintenance information which is important but not hazard related.

By understanding what **DANGER**, **WARNING**, **CAUTION**, and **NOTICE** mean; and using good judgment and common sense; all personnel can avoid injuring themselves and/or damaging the paving breaker.

to make all personnel aware of the hazards while working on or near a paving breaker. All personnel must use common sense and a good working practice while operating and maintaining the paving breaker. The safety precautions listed are of a general nature and cannot cover every possible situation:

4. SAFETY PRECAUTIONS.

The Safety Precautions listed are intended

	⚠ WARNING
	Do not start the paving breaker while it is lying on the ground.

	⚠ WARNING
	Keep your hands off the throttle lever until it is time to start paving breaker operation.

	⚠ CAUTION
	Always wear gloves when operating this tool.

	⚠ WARNING
	Keep legs and feet clear of the paving breaker tool to prevent injury if the tool breaks.

	⚠ WARNING
	Always wear safety shoes when operating this tool.



	⚠ WARNING
	Do not ride the paving breaker with one leg over the handle.



	⚠ CAUTION
	Always wear nose mask when operating this tool.



	⚠ WARNING
	Operate at 90-100 psig (6.2-6.9 bar) Maximum air pressure.

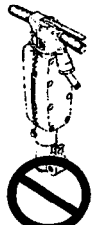

	⚠ WARNING
	Always wear approved hard hat when operating this tool.



	⚠ WARNING
	Always turn off the air supply and bleed and disconnect the air supply hose before installing, removing or adjusting any accessory on this tool.

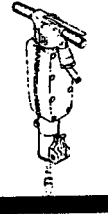

	 CAUTION
	<p>Always wear eye protection when operating this tool.</p>



	 WARNING
	<p>Do not operate the paving breaker without a paving breaker tool locked in the fronthead. Hold the tool firmly against the work.</p>



	 CAUTION
	<p>Always wear hearing protection when operating this tool.</p>



	 WARNING
	<p>Know what is underneath the material you are about to break. Be alert for any buried water, gas, sewer, telephone, or electric lines.</p>

	 WARNING
	<p>Never rest the paving breaker on your foot.</p>

	 WARNING
	<p>Do not use damaged, frayed or deteriorated air hose and fittings.</p>

	 WARNING
	<p>Always keep both hands on the handles while operating the paving breaker.</p>

	 WARNING
	<p>Keep body stance balanced and firm. Do not overreach when operating this tool.</p>

	 WARNING
	<p>Air powered tools can vibrate in use. Vibration, repetitive motions or uncomfortable positions may be harmful to your hands and arms. Stop using any tool if discomfort, tingling feeling or pain occurs. Seek medical advice before resuming use.</p>



Always follow manufacturer instructions

AAA Rent-All 225-291-1356

Alphabetical Index

<u>Title</u>	<u>Page No.</u>
Description	1
Introduction	1
Optional Equipment	1
Standard Equipment	1

1. INTRODUCTION.

This section provides a description of standard and optional equipment for the Paving Breaker Models PB35A, PB35AS, PB50A & PB50AS.

2. DESCRIPTION.

Paving Breaker Models PB35A, PB35AS, PB50A & PB50AS are (in consecutive order) light-duty and medium-duty paving breakers that provide maximum performance at minimum cost. They are designed for general paving breaker work where their size and weight range is necessary. With the two-piece design (breaker housing and fronthead) the paving breaker is easier to disassemble and reassemble.

They are especially suitable for breaking up concrete, asphalt, or stone paving in road construction and maintenance work, breaking up large rocks and boulders in mines and quarries; and general demolition work in any industry.

3. STANDARD EQUIPMENT.

Each paving breaker is a complete unit ready to be put into service with proper lubrication. There are no extra parts or special fittings required.

The **PB35A & PB35AS** have a fronthead bushing which accommodates a 1 in. Hex. x 4-1/4 in. long (25mm Hex. x 108mm long) drill steel shank.

The **PB50A & PB50AS** have a fronthead bushing which accommodates a 1-1/8 in. Hex. x 6 in. long (28mm Hex. x 152mm long) drill steel shank.

The paving breakers furnished with no muffler are designated as **PB35A & PB50A**.

The paving breakers furnished with a muffler are designated as **PB35AS & PB50AS**.

4. OPTIONAL EQUIPMENT.

The paving breakers can also be furnished with the following options:

a. **Fronthead Assemblies :**

1.) 1 in. Hex. x 4-1/4 in. long (25mm Hex. x 108mm long) drill steel shank and is used on the PB35A, PB35AS; PB50A & PB50AS.

Notice: This fronthead assembly is for European customers.

2.) 1-1/4 in. Hex. x 6 in. long (32mm Hex. x

152mm long) drill steel shank and is used on the PB50A & PB50AS.

b. **Muffler Assembly** – Used to reduce paving breaker noise without hendering performance.

c. **Flex Handles** – These handles are used to reduce the amount of vibration that the operator encounters.

Alphabetical Index

<u>Title</u>	<u>Page No.</u>
Air Requirements	1
Air Hose and Fittings	1
Before Operation	2
Controls	2
Introduction	1
Lubrication	4
Methods Of Lubrication	4
Lubricating Oil Specifications	5
Operation	2
Operational Tips	3

1. INTRODUCTION.

This section provides installation and operation requirements for the Paving Breaker Models PB35A, PB35AS & PB50A, PB50AS.

Low or inadequate air pressure at the paving breaker is costly and wasteful, and an insufficient volume of air will not allow it to operate efficiently.

2. AIR REQUIREMENTS.

An air compressor of sufficient capacity is needed to provide the necessary volume of air at the most efficient operating pressure to ensure effective and economical operation of the paving breaker. Refer to Section 5, Paragraph 3 for air requirements of the paving breakers.

The figures represent air pressures at the paving breaker inlet and not at the compressor. There is always a certain amount of pressure drop between the compressor and the paving breaker; only the pressure and volume at the tool is effective in doing work. If the hose is relatively short and in good condition, the pressure drop between the compressor (or air receiver) and the paving breaker should not exceed 15 percent of the initial pressure.

3. AIR HOSE AND FITTINGS.

Quality hose designed especially for rock drill service should be used. It should be constructed with an outer covering that resists abrasive wear, an oil-resistant inner tube and should be able to withstand the heat of the compressed air. It should have a working pressure safety factor of at least 4 to 1 in relation to burst.

The hose fittings should be kept as tight as possible and should be in good condition. Elimination of leakage involves making the air system tight and then keeping it tight. Air losses through bad connections and worn hose can often reach 10 to 20 percent of the total air compressed. Refer to Section 5 for the size air hose required.

4. BEFORE OPERATION.

- a. Determine the method of lubrication to be used. (Refer to Paragraph 9.)
- b. Fill the oil reservoir with rock drill oil conforming to the physical and chemical properties listed in Section 5, Table 1.
- c. Blow out the main air supply hose to get rid of moisture, rubber particles, and dirt.
- d. When using new air hose, blow lubricated air through the hose to completely coat the inside with oil. This may take 10 to 15 minutes.

▲WARNING

COMPRESSED AIR IS DANGEROUS. WHEN BLOWING OUT AN AIR HOSE, HOLD IT FIRMLY, AND POINT IT AWAY FROM PERSONNEL AND EQUIPMENT. NEVER BLOW YOUR CLOTHES FREE OF DUST WITH COMPRESSED AIR.

- e. An air line filter can be installed in the main air supply line to keep dirt from entering the paving breaker. Air line filters are an accessory item and must be specially ordered.
- f. Connect the leader hose to the air connection on the paving breaker.

▲WARNING

BE SURE ALL HOSE CONNECTIONS ARE TIGHT. A LOOSE HOSE NOT ONLY CAUSES LEAKS, BUT CAN COME COMPLETELY OFF THE PAVING BREAKER, WHIP AROUND, AND INJURE PERSONNEL IN THE AREA. ATTACH SAFETY CABLES TO ALL HOSES TO PREVENT INJURY IF A HOSE IS ACCIDENTALLY BROKEN.

- g. Open the latch by pushing the lever down.

- h. Insert the shank end of the paving breaker tool in the fronthead, and swing the latch up to lock the tool in the paving breaker. Refer to Section 5, Paragraph 3 for the correct paving breaker shank sizes of the model paving breaker being used.

▲CAUTION

MAKE SURE THE TOOL IS THE CORRECT SIZE FOR THE FRONT-HEAD. DON'T USE A PAVING BREAKER TOOL THAT IS DULL; IT WON'T DO AN EFFECTIVE JOB AND WILL CAUSE UNNECESSARY WEAR TO THE BREAKER.

5. CONTROLS.

The paving breaker is controlled by a self-closing, lever-operated, throttle valve that is built into the handle:

When air pressure is directed to the paving breaker, the throttle lever will be in the raised, or off, position. The paving breaker will not start until the lever is depressed. The lever will return to the off position when it is released.

6. OPERATION.

▲DANGER

- a. **KNOW WHAT IS UNDERNEATH THE MATERIAL YOU ARE ABOUT TO BREAK. BE ALERT FOR ANY EXISTING WATER, GAS, ELECTRICITY, SEWER, OR TELEPHONE LINES.**
- b. **ALWAYS KEEP BOTH HANDS ON THE HANDLE WHILE OPERATING THE PAVING BREAKER.**

- c. **THE OPERATOR MUST KEEP HIS LEGS AND FEET CLEAR OF THE PAVING BREAKER TOOL TO PREVENT INJURY IF THE TOOL BREAKS. WHEN A TOOL BREAKS, THE PAVING BREAKER (WITH A PIECE OF BROKEN TOOL PROJECTING FROM THE FRONTHEAD) WILL SUDDENLY DROP TO THE GROUND.**

⚠ CAUTION

DO NOT OPERATE THE PAVING BREAKER WITHOUT A PAVING BREAKER TOOL IN THE FRONT-HEAD BUSHING. HOLD THE TOOL FIRMLY AGAINST THE WORK.

1. Grip the paving breaker handle with both hands. Depress the throttle valve lever with the palm of the hand, and apply firm steady pressure to the handles. The correct amount of pressure for maximum efficiency can be gained only by experience, but generally the correct pressure is usually recognizable by the rhythmic sound of the exhaust and maximum breaking action. Insufficient pressure will slow down the paving breaker action. Do not "ride" the paving breaker with one leg over the handle.

⚠ DANGER

THE OPERATOR WILL BE SERIOUSLY INJURED IF THE TOOL BREAKS WHILE HE IS RIDING THE PAVING BREAKER WITH ONE LEG OVER THE HANDLE.

⚠ CAUTION

RIDING THE PAVING BREAKER HANDLE CREATES EXCESSIVE PRESSURE ON ONE SIDE OF THE PAVING BREAKER, THROWING IT OUT OF ALIGNMENT AND CAUSING UNNECESSARY WEAR ON INTERNAL PARTS.

2. Immediately after starting the paving breaker, check for the presence of oil mist at the exhaust port and on the paving breaker tool. This is the only assurance that oil is traveling all the way through the breaker. When checking the paving breaker for proper lubrication, always put the tool against the work.

3. Release the throttle-valve lever to shut the paving breaker off.

4. If exhaust freeze-up occurs, add anti-freeze lubricant directly through the air inlet connection. Use an anti-freeze lubricant recommended for air tools.

7. OPERATIONAL TIPS.

For maximum operating efficiency, observe the following suggestions:

a. Never strike the paving breaker with a blunt object; the housing may be broken or damaged.

b. Never attempt major maintenance of the paving breaker on the job; take it to a repair shop.

c. Never drag the paving breaker along the ground; the air ports in the exhaust may fill with dirt.

d. Always blow out the air supply hose before connecting it to the paving breaker to remove any dirt inside the hose.

e. Always be sure the paving breaker is well lubricated. Adjust the air line lubricator so

that the paving breaker tool always shows an oil film. There should be a fine mist of oil coming out of the exhaust port.

f. Always keep rock drill oil in a sealed container so that it doesn't get contaminated with dust or dirt.

g. Do not operate the paving breaker when the tool is not against the work.

h. In extremely cold weather, keep paving breaker tools wrapped in burlap or cloth until just before you use them. At 0°F (-17.8°C) a hardened steel tool loses about 80% of its normal shock resistance.

i. Always keep plastic caps or plugs in all ports when the paving breaker is not in service.

j. Work to the predetermined line (boundary) and grade (depth). Cut straight and cut neatly. To get the exact grade, use a tape measurer or ruler.

k. In certain applications, such as a pipe job where the grade is critical, it pays to over-excavate. If you try to excavate exactly to grade, even a small piece of rock sticking up will throw the pipe off grade. To avoid this problem, excavate a little deeper than grade, then fill and compact to the correct grade. This is easier than having to come back and break out more rock.

l. Always score a sidewalk or portion of a slab before breaking it. This is usually done with a concrete saw, but if it has not been, use the paving breaker to score the job along the designated line to ensure a clean break. When cutting asphalt, cut all the way through the asphalt with each cut, as well as all the way around the perimeter of the area, before you break the asphalt out.

m. When excavating to a critical line for installation of a service, square the sides of the

excavation as you work down. Otherwise, you'll either under-cut or over-cut.

n. When making an excavation to work in, it's better to make a larger opening than required to provide ample working room.

o. Always break any material to the point of "give". This is accomplished by making sure you're breaking the concrete or rock, not just cracking it; otherwise, you're not working to the point of give. Always clear away the rubble as you're breaking the concrete, rock, or asphalt. Uncleared rubble blocks your point of give.

p. Always take the right sized "bite" with the paving breaker. When starting to work the paving breaker in a material, experiment to find the right sized bite for breaking that material efficiently.

If you take bites that are too big, it will be necessary to pry with the paving breaker tool. This could break the tool or damage the paving breaker. The paving breaker is not designed for prying; it's designed for breaking. Always use a pick to pry material free.

If you take bites that are too small, you'll be working too slowly, and you'll have to pick up and move the paving breaker more than necessary.

8. LUBRICATION.

The paving breaker is initially supplied with a small amount of lubricating oil in the paving breaker lubrication reservoir, but should be checked and filled before use. Always check the oil level in the reservoir before each start up.

9. METHODS OF LUBRICATION.

Proper lubrication is the most important single factor responsible for the service life of the pneumatic paving breaker. A paving breaker can be severely damaged during the

first few minutes of operation if it is not properly lubricated.

The lubrication method depends on the actual operating conditions and customer preference.

NOTE: While the PB50 series breaker have a built in oil reservoir, the PB35 series breakers Do Not. They are lubricated by using a constant feed air line lubricator.

▲CAUTION

THE BUILT-IN OIL RESERVOIR IN THE HOUSING PLUG MUST BE CHECKED EVERY TWO HOURS AND REFILLED AS NECESSARY.

a. The oil reservoir built into the PB50 series breaker housing plug will provide proper lubrication. It must be checked every two hours and refilled as necessary.

b. For intermittent operation with an air supply hose no longer than 50 ft. (15 m), a compressor-mounted lubricator may be used.

c. For continuous operation during an eight hour shift, an Ingersoll-Rand® air line lubricator, or other constant-feed air line lubricator, should be installed in the air-supply line about 11.5 ft. (3.5 m) from the paving breaker. The lubricator listed in the parts list has a capacity of 1 U.S. pint (0.47 liters) and will be furnished when it is specially ordered. To adjust an air line lubricator initially:

1. Turn the lubricator needle valve clockwise until it is completely closed, and then turn the valve counter-clockwise about 3/4 of a turn off its seat.

2. Almost immediately after starting the paving breaker, check for the presence of oil at the exhaust ports and on the paving breaker tool. When checking the paving breaker for proper lubrication, always put the tool against the work.

3. Fine-tune the lubricator needle valve to provide a light film of oil on the paving breaker tool and a fine oil mist coming from the exhaust ports. If there is blue smoke coming from the exhaust port or oil running down the tool, the paving breaker is getting too much oil. Adjust the lubricator for proper rate of feed.

d. Regardless of the method of lubrication, the lubricating oil reservoir must be filled with the correct grade of rock drill oil as frequently as is necessary to prevent any possibility of the paving breaker running dry.

e. The supply of lubricant in the housing plug reservoir should be checked every two hours of operating time.

f. The oil level in the air line lubricator should be checked at the beginning of each eight-hour shift and once during the shift.

g. Every effort must be made to avoid oil contamination from dirt or other impurities. Oil should be kept in covered containers and stored in an area that is relatively dust free.

h. Before filling the air line lubricator, the area around the filler plug should be wiped clean.

10. LUBRICATING OIL SPECIFICATIONS.

Ingersoll-Rand® offers a complete line of rock drill oil formulated in all types of rock drill equipment. These oils exceed the oil specifications listed in Section 5, Table 1.

▲CAUTION

NEVER ALLOW THE LUBRICATOR TO BECOME EMPTY AS THE PARTS WILL BE DAMAGED IF THE PAVING BREAKER IS OPERATED WITHOUT LUBRICATION.

Use Section 5, Table 2 for the correct viscosity grade selection to meet your requirements and Section 5, Table 3 for selecting the correct rock drill oil part number.



Always follow manufacturer instructions

AAA Rent-All 225-291-1356

Alphabetical Index

<u>Title</u>	<u>Page No.</u>
Lubricating Oil Chart	1
Paving Breaker Illustration	4
Paving Breaker Specifications	2
Vibration and Noise Data	2

1. LUBRICATING OIL CHART.

Table 1. Rock Drill Oil Specifications

Characteristic	Test Procedure	Below 20°F (-7°C)	20°F to 90°F (-7°C to 32°C)	Above 90°F (32°C)
Viscosity:				
SUS at 100°F (38°C)	ASTM-D2161	175 Min.	450 Min.	750 Min.
SUS at 210°F (99°C)	ASTM-D2161	46 Min.	65 Min.	85 Min.
cST at 104°F (40°C)	ASTM-D445	37 Min.	105 Min.	160 Min.
cST at 212°F (100°C)	ASTM-D445	6 Min.	11 Min.	16 Min.
Pour Point, °F (°C) Max.	ASTM-D97	-10°F (-23°C)	-10°F (-23°C)	0°F (-18°C)
Flash Point, °F (°C) Min.	ASTM-D92	370°F (188°C)	400°F (204°C)	450°F (232°C)
Viscosity Index, Min.	ASTM-D2270	90	90	90
Steam Emulsion No. Min.	ASTM-1935-65	1200	1200	1200
Consistency	Stringy	Stringy	Stringy
Falex Load Test lbs (kg) [Min]	ASTM-D2670	2000 lbs (907 kg)	2000 lbs (907 kg)	2000 lbs (907 kg)
Timken E.P. Test lbs (kg) [Min]	ASTM-D2782	30 lbs (14 kg)	30 lbs (14 kg)	30 lbs (14 kg)

Table 2. Selection Chart

Typical Operating Conditions	20°F to 90°F (-7°C to 32°C)	Above 90°F (32°C)
90-100 psi (6.2 to 6.9 bar)	Light	Medium

Table 3. Ingersoll-Rand Rock Drill Oil Part Numbers

Grade	1 Gallon	5 Gallon	55 Gallon
Light	51378701	51378727	51378743
Medium	51378693	51378719	51378735

2. VIBRATION AND NOISE DATA.

NOTICE

In compliance with **EC Directive 84/537/EEC on Noise** at the workplace, the following data is supplied:

The following are average sound pressure levels:

PB35AS	106 dB(A)
PB50AS	111 dB(A)

NOTICE

In compliance with **Weighted RMS Acceleration ISO 8662, Part 5 on Vibration**, the following data is supplied:

PB35A	N/A
PB35AS	N/A
PB50A	37.2 m/s ²
PB50AS	37.2 m/s ²
PB50AF	9.1 m/s ²
PB50ASF	9.1 m/s ²

3. PAVING BREAKER SPECIFICATIONS.

a. Net Weight (less tool):

PB35A	39 lbs	18 kg
PB35AS	43 lbs	20 kg
PB50A	52 lbs	24 kg
PB50AS	55 lbs	25 kg

b. Shipping Weight (less tool):

PB35A	41 lbs	19 kg
PB35AS	45 lbs	20.4 kg
PB50A	54 lbs	25 kg
PB50AS	56 lbs	25.4 kg

c. Overall Length (less tool):

PB35A/AS	25 in.	635 mm
PB50A/AS	27.5 in.	698 mm

d. Bore of Cylinder:

PB35A/AS	1.75 in.	44 mm
PB50A/AS	1.75 in.	44.5mm

e. Working Stroke:

PB35A/AS	6.25 in.	159 mm
PB50A/AS	6.25 in.	159 mm

f. Recommended Air Supply:

90 -100 psi (6.2 - 6.9 bar) at paving breaker inlet.

g. Air Inlet Size:

All Models	3/4 NPT
------------	---------



Always follow manufacturer instructions

AAA Rent-All 225-291-1356

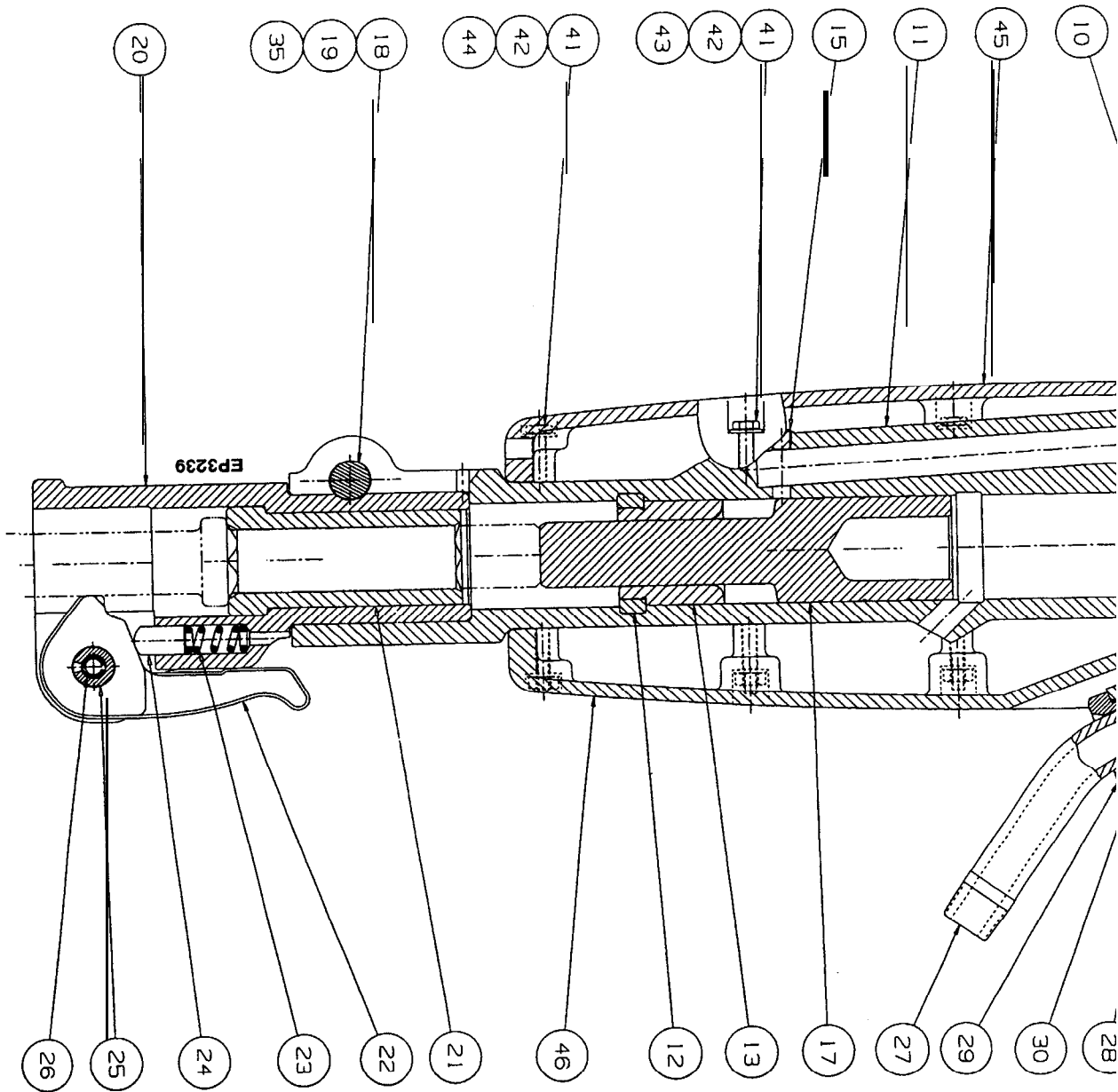

Paving Breaker – Sectional Illustration
 (Refer to Page 4 for parts legend)

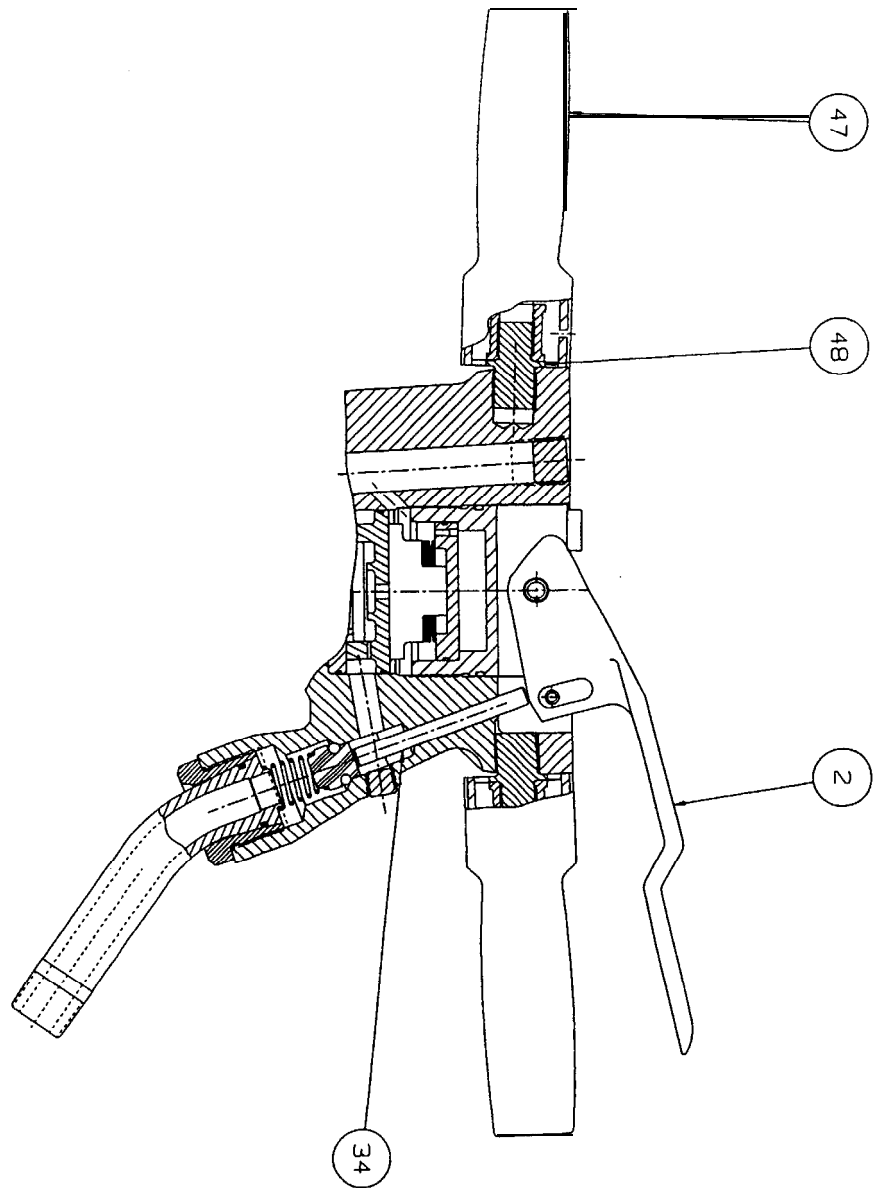
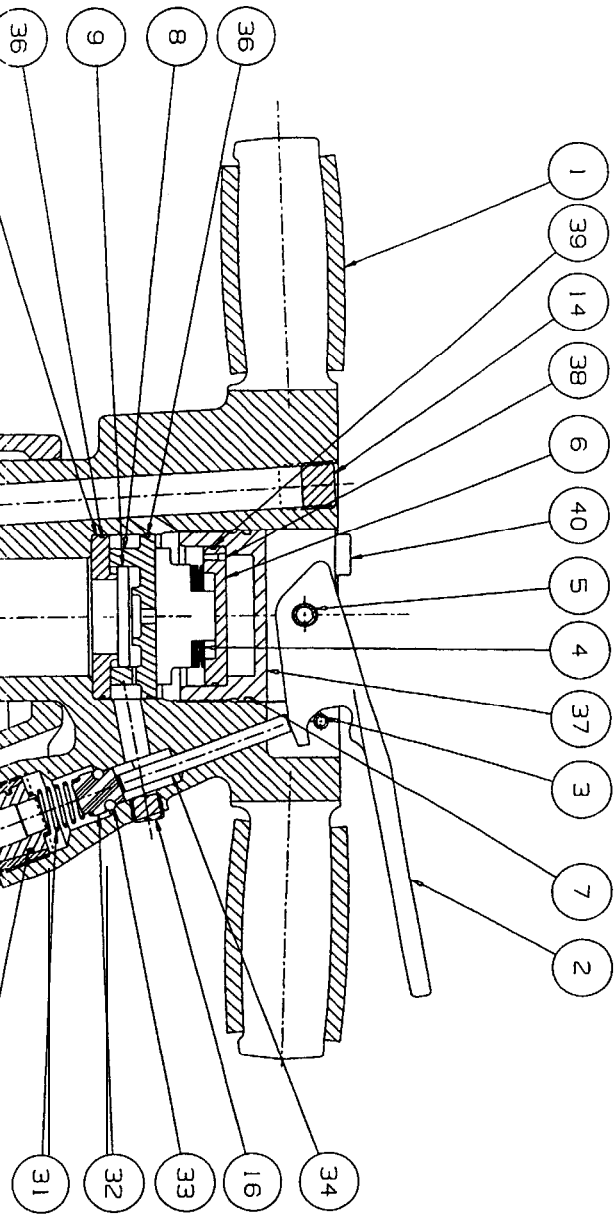

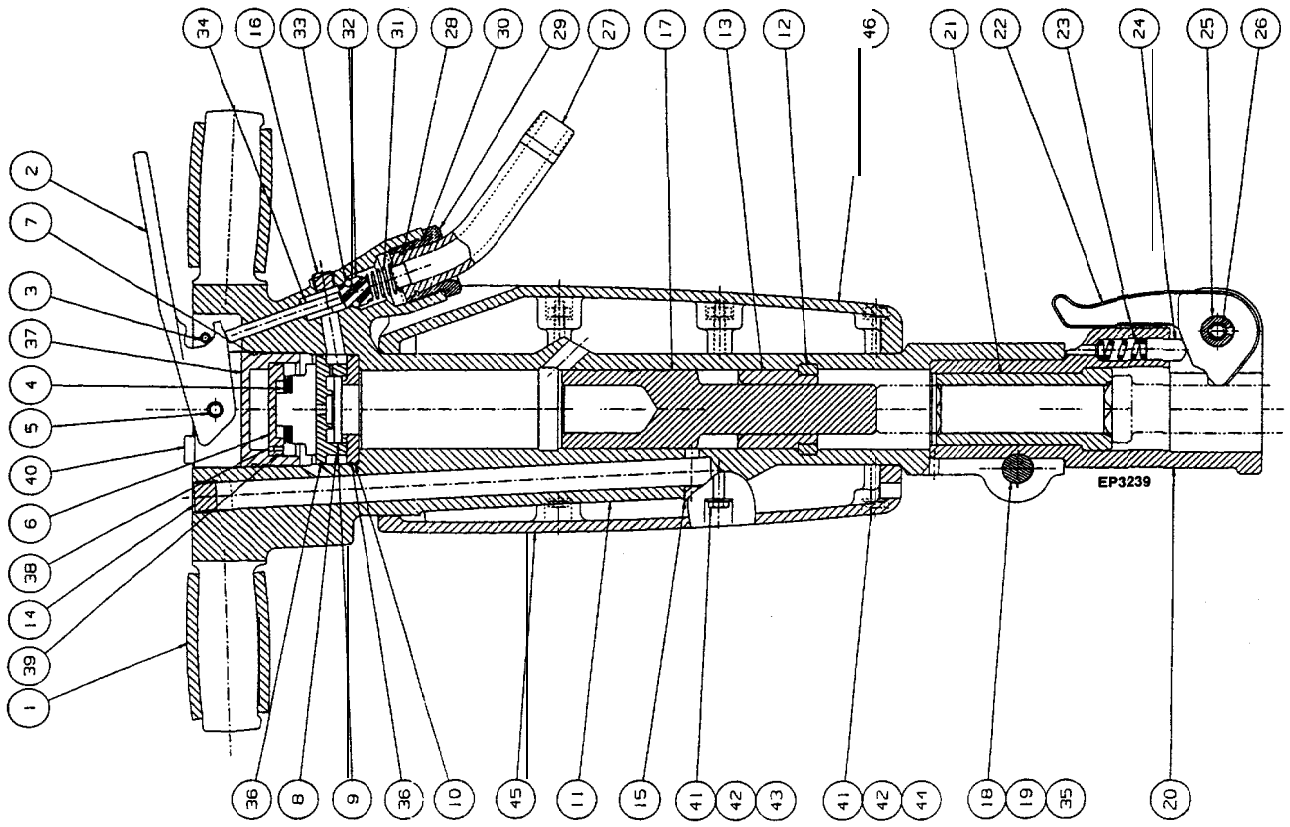
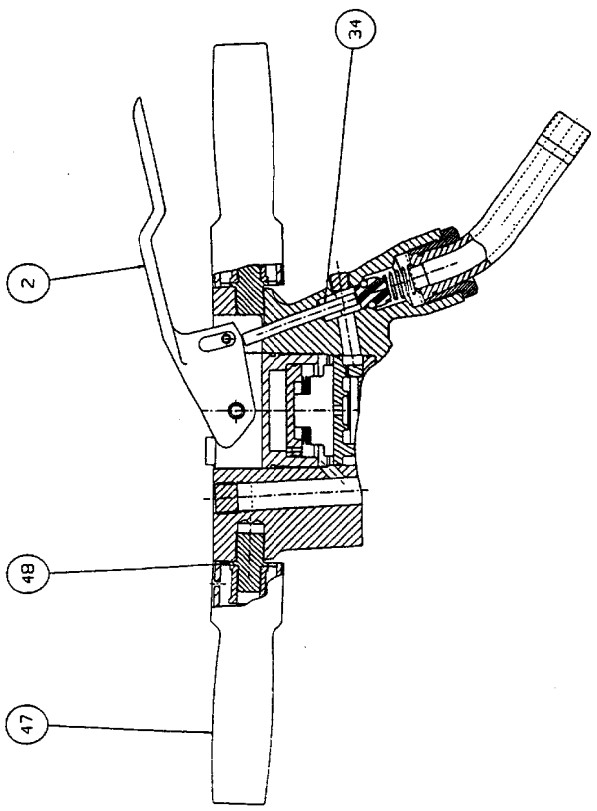

Paving Breaker-- Sectional illustration
(Refer to Page 4 for parts legend)



Always follow manufacturer instructions

AAA Rent-All 225-291-1356

Worldwide Ingersoll-Rand sales offices

U.S.A.

U.S. C&M OFFICES

Bethlehem, PA 18017-2293
1495 Valley Center Pkwy.
215/852-8800

Boston, MA 02125
33 Locust Street
617/288-8988

Casper, WY 82601
3273 N. I-25 Frontage Road
307/237-4259

Denver, CO 80207
5805 East 39th Ave.
303/399-1580

East Hanover, NJ 07936
98 Route #10
201/887-1212

Elkridge, MD 21227
5681 Main Street
410/796-3200

Gray, TN 37615
Suncrest Drive
615/477-3114

Houston, TX 77001
2210 McAllister
713/681-9221

Knoxville, TN 37922 (C&M)
112 Glenleigh Court
Suite #1
615/966-8800

Knoxville, TN 37912 (IRES)
4726 Clinton Hwy.
615/525-0404

Milwaukee, WI 53225
12311 West Silver Springs Dr.
414/461-7810

Nashville, TN 37229
310 S. Second St.
615/254-1811

New Castle, DE 19702
91 Christiana Road
302/324-9040

New Cumberland, PA 17070
Exit 15 on Rt. 83
4 miles south of Harrisburg
717/938-1441

New England
300 Turnpike Rd. -Route 9
Southboro, MA 01772
508/481-1350

Philadelphia
Route 309
Montgomeryville, PA 18936
215/855-9990

Phoenix, AZ 85007
820 N. 17th Ave.
602/258-6493

Pico Rivera, CA 90660
5211 Paramount Blvd.
310/948-3801

Portland, OR 97214
240 South East Clay Street
503/232-0151

Sacramento, CA 95836
1851 Bell Avenue
916/641-1994

San Leandro, CA 94577
1944 Marina Blvd.
510/357-9131

Scranton, PA 18505
605 Davis St.
717/346-3885

Seattle, WA 98168
11222 E. Marginal Way, S.
206/762-7400

U.S. C&M FACTORIES
ROCK DRILLS

Rotary blasthole deephole,
monitoring rigs
Ingersoll-Rand Co.
Rotary Drill Division
2100 N. First St.
Garland, TX 75040
214/495-8181

Downhole Drills and Bits; Pneumatic
and Hydraulic Crawler Drills; Anchor
Drills; Breakers and Jackhammers™.
Ingersoll-Rand Co.
Rock Drill Division
7500 Shadwell Drive
Roanoke, VA 24019-5198
703/362-3321

COMPACTORS, PAVING
MILLERS, ASPHALT PAVERS
AND FORKLIFTS

Ingersoll-Rand Co.
Road Machinery Division
Ingersoll Drive
Shippensburg, PA 17257
717/532-9181

UNDERGROUND EQUIPMENT
Roadheaders; drill jumbos, diesel-
powered production and utility equip-
ment (scoops, haul dumps, etc.)
Contact Rock Drill Division
Roanoke, VA

Split Set rock stabilizers
Simmons - Rand Co.
Split Set Division
Suite 300
100 Thanet Circle
Princeton, NJ 08540-3662
609/921-8688

AIR COMPRESSORS
Portable compressors, Generator
Sets and Light Plants
Ingersoll-Rand Co.
Portable Compressor Division
P.O. Box 868
501 Sanford Ave.
Mocksville, NC 27028
704/634-3561

Small Compressor Plant
Ingersoll-Rand Co.
101 Industrial Drive
Campbellsville, KY 42718
502/465-3511

Centrifugal compressors (Centac)
Ingersoll-Rand Co.
Centrifugal Compressor Division
Route 45
Mayfield, KY 42066
502/247-8640

Reciprocating and rotary-screw
compressors
Ingersoll-Rand Co.
Air Compressor Group
P.O. Box 1600
800A Beaty St.
Davidson, NC 28036
704/892-7100

PUMPS

Engineered centrifugal pumps
Ingersoll-Rand Co.
P.O. Box 486
Phillipsburg, NJ 08865
201/859-7000

Reciprocating pumps and standard
centrifugal pumps
Ingersoll-Rand Co.
P.O. Box 656
Allentown, PA 18105
215/433-6411

Vertical turbine pumps
Ingersoll-Rand Co.
Vertical Turbine Pump Division
Hastings, NE 68901
402/463-1306

TOOLS, WINCHES

Ingersoll-Rand Co.
Power Tool Division
P.O. Box 1776
Liberty Corner, NJ 07938
201/647-6000

LIQUID/SOLID SEPARATORS

Ingersoll-Rand Co.
Impco Division
150 Burke St.
Nashua, NH 03061
603/882-2711

CANADA

Surface and underground equipment
Tools and industrial equipment

Ingersoll-Rand Canada Inc.
2360 Millrace Court
Mississauga, Ontario L5N1W2
(1)416/858-8480

Ingersoll-Rand Canada, Inc.
2250 Hymus Blvd
Dorval, Quebec H9P1J9
(1) 514/683-9157

MEXICO

All equipment
Ingersoll-Rand, S.A. de C.V.
Boulevard Centro
Industrial #11
Fracc. Industrial
Puente de Vigas
Tlalnepanitla,
54090 Edo, de Mexico
Mexico
52 (5) 390-40-21
52 (5) 390-24-11

SOUTH AMERICA

USA, Miami, Florida
1 (305) 599-0500

Chile - Santiago
56 (2) 41-198

Colombia - Bogota
57 (1) 219-1406/1460

Venezuela - Caracas
58 (2) 239-9369

EUROPE

Austria - Vienna
43 (222) 83-05-250

Belgium - Brussels
32 (02) 216-99-95

France - Trappes
33 (3) 050-61-10

Germany - Ratingen
49 (2102) 48090

*Italy - Milano
39 (02) 950561

Netherlands - Zoeterwoude
31 (071) 452200

Norway - Oslo
47 (02) 39-15-26

Spain - Madrid
34 (9) 1-671-07-00

Sweden - Spanga
46 (08) 750-59-20

United Kingdom - London
44 (01) 584-5070

*Also for Bulgaria, Czechoslovakia,
Hungary, Poland, Rumania, USSR,
Yugoslavia.

AFRICA-MIDDLE EAST

Egypt - Cairo
(02)341-5190

South Africa - Atrode
27 (011) 864-3930

ASIA-PACIFIC

Australia-Melbourne
61-(3) 794-1611

Hong Kong
852 (5) 270183

India-Bombay
91 (22) 4936765

Japan - Tokyo
81 (3) 403-08417

Korea - Seoul
82 (2) 776-2541

New Zealand - Auckland
64 (9) 885096

Philippines - Manila
63 (2) 89-85-06/08

Singapore
(65) 8611555

h. Size Air Hose Recommended:

All Models 3/4 in. 19 mm

i. Air Consumption @ 90 psi (6.2 bar):

PB35A/AS 49 ft³/min 1.4 m³/min

PB50A/AS 58 ft³/min 1.6 m³/min

j. Standard Paving Breaker Shank Size:

PB35A/AS 1 in. Hex. x 4-1/4 in. long
(25mm Hex. x 108mm long)

PB50A/AS 1-1/8 in. Hex. x 6 in. long
(28mm Hex. x 152mm long)

**Legend for Paving Breaker Sectional Illustration
(Refer to Page 5 for Illustration)**

- | | |
|---------------------------------|------------------------------|
| 1. HANDLE SLEEVE | 25. ROLL PIN |
| 2. THROTTLE LEVER | 26. ROLL PIN |
| 3. ROLL PIN | 27. AIR CONNECTION |
| 4. WASHER | 28. O-RING |
| 5. ROLL PIN | 29. AIR CONNECTION CAP |
| 6. OILER PLATE | 30. O-RING |
| 7. O-RING | 31. SPRING |
| 8. VALVE CHEST | 32. VALVE |
| 9. VALVE | 33. O-RING |
| 10. VALVE COVER | 34. THROTTLE PIN |
| 11. BREAKER HOUSING | 35. WASHER |
| 12. PISTON SEAT | 36. O-RING |
| 13. RETAINING BUSHING | 37. HOUSING PLUG |
| 14. PIPE PLUG | 38. FILTER |
| 15. PIPE PLUG | 39. O-RING |
| 16. PIPE PLUG | ■ **40. PLUG, OILER FILL |
| 17. PISTON | 41. WASHER (MUFFLER VERSION) |
| 18. BOLT | 42. NUT (MUFFLER VERSION) |
| 19. NUT | 43. SCREW (MUFFLER VERSION) |
| 20. FRONTHEAD | 44. SCREW (MUFFLER VERSION) |
| 21. FRONTHEAD BUSHING | 45. MUFFLER, RIGHT SIDE |
| 22. STEEL RETAINING LEVER | 46. MUFFLER, LEFT SIDE |
| 23. SPRING | 47. FLEX HANDLE (OPTIONAL) |
| 24. STEEL RETAIN. LEVER PLUNGER | 48. HANDLE STUD (OPTIONAL) |

■ ** – PB50 Series Only
PB35 Series does not have an oiler fill plug. It is lubricated using a line lubricator.